

## Serie 57000

 <b>57000</b> Pag. 3.7	 <b>57010</b> Pag. 3.7	 <b>57020</b> Pag. 3.8	 <b>57030</b> Pag. 3.8	 <b>57040</b> Pag. 3.8	 <b>57050</b> Pag. 3.9	 <b>57060</b> Pag. 3.9	 <b>57100</b> Pag. 3.9	 <b>57106</b> Pag. 3.9
 <b>57111</b> Pag. 3.10	<b>New</b>  <b>57116</b> Pag. 3.10	 <b>57126</b> Pag. 3.10	 <b>57130</b> Pag. 3.11	 <b>57200</b> Pag. 3.11	 <b>57211</b> Pag. 3.11	 <b>57216</b> Pag. 3.12	 <b>57223</b> Pag. 3.12	 <b>57226</b> Pag. 3.12
 <b>57230</b> Pag. 3.13	 <b>57310</b> Pag. 3.13	 <b>57500</b> Pag. 3.13	 <b>57510</b> Pag. 3.13	 <b>57550</b> Pag. 3.14	 <b>57560</b> Pag. 3.14	 <b>51410</b> Pag. 3.14	 <b>51420</b> Pag. 3.15	 <b>51430</b> Pag. 3.15
 <b>51440</b> Pag. 3.15	 <b>50600</b> Pag. 3.15	 <b>57610</b> Pag. 3.16	 <b>50625</b> Pag. 3.16	 <b>57700</b> Pag. 3.16	 <b>57800</b> Pag. 3.16	 <b>55801</b> Pag. 3.17	 <b>55802</b> Pag. 3.17	 <b>50980</b> Pag. 3.18
 <b>50990</b> Pag. 3.18	 <b>50006</b> Pag. 3.18							

**RACCORDI AUTOMATICI METALLICI**

*METALLIC PUSH-IN FITTINGS*

*VOLLMETALL STECKVERSCHRAUBUNGEN*

*RACCORDS INSTANTANÉS TOUT LAITON NICKELÈ*

*RACORDAJE AUTOMÁTICO METÁLICO*

*CONEXÕES PUSH-IN METÁLICAS*

57000

**Serie 57000**





**CARATTERISTICHE TECNICHE**  
 TECHNICAL CHARACTERISTICS  
 TECHNISCHE ANGABEN  
 CARACTÉRISTIQUES TECHNIQUES  
 CARACTERÍSTICAS TÉCNICAS  
 CARACTERÍSTICAS TÉCNICAS



**Norma di Riferimento**  
 Reference standard  
 Entspricht der Norm  
 Norme de référence  
 Normativa de referencia  
 Norma de referència

1907/2006  
**REACH**

2011/65/CE  
**RoHS**

PED  
 2014/68/UE

ISO  
 14743:2004

**SILICON  
 FREE**

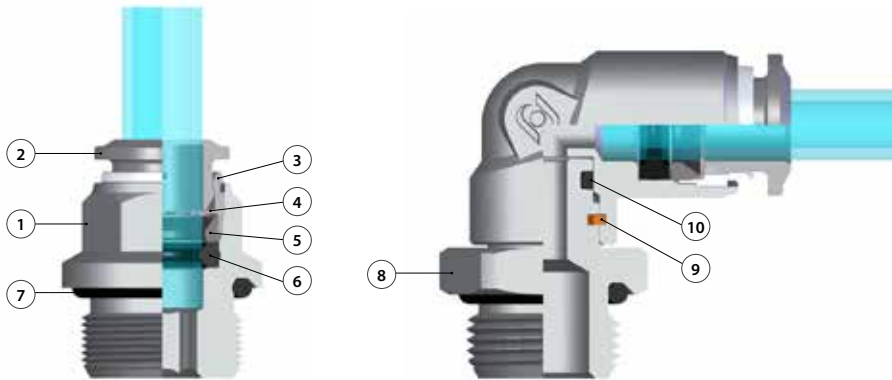

Materiali e Componenti	IT	Component Parts and Materials	GB	Komponenten und Materialien	DE
1 Corpo in ottone nichelato		1 Nickel-plated brass Body		1 Körper Messing vernickelt	
2 Spintore sgancio tubo in Ottone nichelato		2 Nickel-plated brass Collet		2 Rohr Lösering Messing vernickelt	
3 Capsula in ottone nichelato		3 Nickel-plated brass Capsule		3 Haltering Messing vernickelt	
4 Pinza d'aggraffaggio in acciaio inox AISI 301		4 Steel AISI 301 Clamping washer		4 Zahnscheibe Edelstahl AISI 301	
5 Anello di posizionamento in tecnopolimero		5 Technopolymeric positioning ring		5 Positionierring Technopolymer	
6 Guarnizione sagomata in NBR (EPDM a richiesta)		6 NBR Molded seal (if requested EPDM)		6 Lippendichtung NBR (EPDM auf Anfrage)	
7 Guarnizione filetto in NBR (EPDM a richiesta)		7 NBR Thread packing (if requested EPDM)		7 Gewindeabdichtung NBR (EPDM auf Anfrage)	
8 Basetta Filettata in Ottone Nichelato		8 Base Threaded Nickel Plated Brass		8 Gewindebasis Messing vernickelt	
9 Seeger		9 Seeger		9 Seeger	
10 Guarnizione in NBR (EPDM a richiesta)		10 NBR seal (if requested EPDM)		10 Lippendichtung NBR (EPDM auf Anfrage)	

Matériaux et Composants	FR	Materiales y Componentes	ES	Materiais e Componentes	PT
1 Corps: Laiton nickelé		1 Cuerpo en latón niquelado		1 Corpo em latão niquelado	
2 Pousoir: Laiton nickelé		2 Anillo de extracción tubo en latón niquelado		2 Anilha de liberação em latão niquelado	
3 Capsule de retenue: Laiton nickelé		3 Cápsula en latón niquelado		3 Cápsula de latão niquelado	
4 Rondelle d'accrochage: AISI 301		4 Pinza de agarre en acero inox AISI 301		4 Pinça de travamento em aço-inox AISI 301	
5 Anneau de positionnement: Technopolymère		5 Anillo de posicionamiento en tecnopolímero		5 Anel de posicionamento em tecnopolímero	
6 Joint à lèvre: NBR (EPDM sur demande)		6 Junta de forma en NBR (EPDM bajo pedido)		6 Vedação em NBR (EPDM sob encomenda)	
7 Joint d'étanchéité du filetage: NBR (EPDM sur demande)		7 Junta rosca en NBR (EPDM bajo pedido)		7 Vedação da rosca en NBR (EPDM sob encomenda)	
8 Bague de sécurité en laiton nickelé		8 Base rosca en latón niquelado		8 Base rosca en latão niquelado	
9 Seeger		9 Seeger		9 Seeger	
10 Joint en NBR (EPDM sur demande)		10 Junta en NBR (EPDM bajo pedido)		10 Vedação em NBR (EPDM sob encomenda)	



**Pressioni**  
 Pressures  
 Druckbereich  
 Pressions  
 Presiones  
 Pressões

**- 0.99 bar** (-0.099 MPa)  
**20 bar** (2.0 MPa)



**Fluidi compatibili**  
 Aria compressa / Vuoto / Acqua / Vapore (EPDM)

**Fluids**  
 Compressed air / Vacuum / Water / Steam (EPDM)

**Geeignete Medien**  
 Druckluft / Vakuum / Wasser / Dampf (EPDM)

**Fluides compatibles**  
 Air comprimé / Vide / Eau / Vapeur (EPDM)

**Fluidos compatibles**  
 Aire comprimido / Vacío / Agua / Vapor (EPDM)

**Fluidos compatíveis**  
 Ar comprimido / Vácuo / Água / Vapor (EPDM)



**Temperature**  
 Temperatures  
 Temperatur  
 Températures  
 Temperaturas  
 Temperaturas

**- 20 °C**  
**+ 80 °C**

**EPDM**  
**- 40 °C**  
**+ 130 °C**



Tubi di Collegamento	IT	Connection Tubes	GB	Geeignete Rohre	DE
Tubi in materiale plastico: PA6, PA11, PA12, Polietilene, *Poliuretano, PTFE, FEP. *Per tubi in Poliuretano é consigliata una durezza di 98 shore.		Plastic tubes: PA6, PA11, PA12, Polyethylene, *Polyurethane, PTFE, FEP. *For Polyurethane hoses it is required a minimum hardness of 98 shore.		Kunststoffrohre: PA6, PA11, PA 12, Polyethylene, *Polyurethan, PTFE, FEP. *Für Polyurethan Rohre ist eine Härte von 98 Shore empfohlen.	

Tubes Conseillés	FR	Tubos de Conexión	ES	Tubos de Conexão	PT
Tubes plastiques: PA6, PA11, PA12, Polyéthylène, *Polyuréthane, PTFE, FEP. *Pour les tubes en polyuréthane, il est conseillé une dureté de 98 Shore.		Tubos en material plástico: PA6, PA11, PA 12, Polietileno, *Poliuretano, PTFE, FEP. *Para tubos en poliuretano é aconsejada una durezza de 98 shore.		Tubos em material plástico: PA6, PA11, PA12, Polietileno, *Poliuretano, PTFE, FEP. *Para tubos em Poliuretano é requerida uma durezza de 98 shore.	



<b>Filettatura</b> Gas conica "UNIVERSAL SHORT". Gas conica conforme ISO 7.1, BS 21, DIN 2999. Gas cilindrica conforme ISO 228 Classe A. Metrica conforme ISO R/262.	<b>IT</b>	<b>Threads</b> "UNIVERSAL SHORT" Tapered thread. Tapered gas in conformity with ISO 7.1, BS 21, DIN 2999. Parallel gas in conformity with ISO 228 Class A. Metric in conformity with ISO R/262.	<b>GB</b>	<b>Gewindearten</b> Konisches Gewinde "UNIVERSAL SHORT". Konisches Gewinde nach Norm ISO 7.1, BS 21, DIN 2999. Zylindrisches Gewinde nach Norm ISO 228 Classe A. Metrisches Gewinde nach Norm ISO R/262.	<b>DE</b>
<b>Filetages</b> Filetage conique "UNIVERSAL SHORT". Filetage conique conforme: ISO 7.1, BS 21, DIN 2999. Filetage cylindrique conforme: ISO 228 Classe A. Filetage métrique conforme: ISO R/262.	<b>FR</b>	<b>Roscas</b> Gas cónica "UNIVERSAL SHORT". Gas cónica conforme ISO 7.1, BS 21, DIN 2999. Gas cilíndrica conforme ISO 228 Clase A. Métrica conforme ISO R/262.	<b>ES</b>	<b>Roscas</b> Gas cónica "UNIVERSAL SHORT". Gas cónica conforme ISO 7.1, BS 21, DIN 2999. Gas paralela conforme ISO 228 Classe A. Métrica conforme ISO R/262.	<b>PT</b>



**UNIVERSAL SHORT**

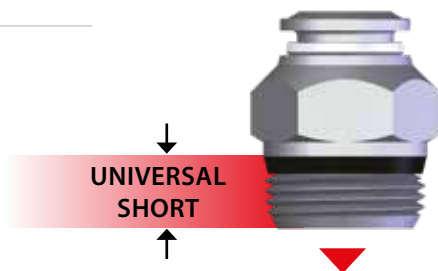

<p><b>NPT</b> <b>NPTF</b></p>	Conica Tapered Konisch Conique Cónica Cônica	<p><b>ISO 7</b> <b>BSPP</b></p>	Cilíndrica Paralell Zylindrisch Cylindrique Cilíndrica Paralela	<p><b>ISO 7</b> <b>BSPT</b> <b>PT</b></p>	Conica Tapered Konisch Conique Cónica Cônica	<p><b>ISO 228</b> <b>BSP</b> <b>PF</b></p>	Cilíndrica Paralell Zylindrisch Cylindrique Cilíndrica Paralela
-----------------------------------	---	-------------------------------------	--	---	---	--	--

<b>"UNIVERSAL SHORT"</b> La filettatura conica "UNIVERSAL SHORT" è progettata per soddisfare le seguenti caratteristiche: <ul style="list-style-type: none"> <li>• ridurre la lunghezza d'ingombro;</li> <li>• ridurre la chiave rispetto ad alcuni raccordi con filettature cilindriche;</li> <li>• consentire l'accoppiamento con diversi standard di filettature femmina sia coniche che cilindriche.</li> </ul>	<b>IT</b>	<b>"UNIVERSAL SHORT"</b> The "UNIVERSAL SHORT" taper thread has been designed to offer the following advantages to the users: <ul style="list-style-type: none"> <li>• reduced overall length;</li> <li>• smaller hex dimensions compared to the parallel threads;</li> <li>• to allow the assembly with different female threads both taper as well as parallel.</li> </ul>	<b>GB</b>	<b>"UNIVERSAL SHORT"</b> Das konische Gewinde "UNIVERSAL SHORT" ist so konzipiert, dass folgende Vorteile erzielt werden: <ul style="list-style-type: none"> <li>• Reduzierung der Länge des Gewindes - kürzere Montagezeit;</li> <li>• Reduzierung der Schlüsselweite im Vergleich von Verschraubungen mit zylindrischen Gewinden - geringerer Lochabstand;</li> <li>• Ermöglicht den Einsatz in verschiedene Gewindearten, sowie in konische- und zylindrische Innengewinde.</li> </ul>	<b>DE</b>
<b>"UNIVERSAL SHORT"</b> Le filetage conique "UNIVERSAL SHORT" a été conçu pour satisfaire les exigences suivantes: <ul style="list-style-type: none"> <li>• réduire la longueur d'encombrement;</li> <li>• réduire les dimensions hexagonales par rapport au filetage cylindrique;</li> <li>• permettre le montage avec divers taraudages standards soit coniques soit cylindriques.</li> </ul>	<b>FR</b>	<b>"UNIVERSAL SHORT"</b> La rosca cónica "UNIVERSAL SHORT" ha sido proyectada para satisfacer las siguientes características: <ul style="list-style-type: none"> <li>• reducir la longitud;</li> <li>• reducir la llave respecto a algunos racores con rosca cilíndrica;</li> <li>• consentir el acoplamiento con diferentes standard de rosas hembra sean cónicas o cilíndricas.</li> </ul>	<b>ES</b>	<b>"UNIVERSAL SHORT"</b> A rosca cónica "UNIVERSAL SHORT" é projetada para satisfazer às seguintes características: <ul style="list-style-type: none"> <li>• reduzir o comprimento da conexão;</li> <li>• reduzir o dimensional com relação às rosas paralelas;</li> <li>• permitir o acoplamento da conexão a diferentes tipos de rosca fêmea, sejam elas cónicas ou paralelas.</li> </ul>	<b>PT</b>



Inclinate  
Inclined  
Geneigt  
Incliné  
Inclinada  
Inclinadas



Concave  
Concave  
Konkav  
Concave  
Cóncava  
Côncavas



Convexe  
Convex  
Konvex  
Convexe  
Convexa  
Convexas

Consentire una completa tenuta anche su superfici non perfettamente piane, concave, convesse o inclinate, con diversi smussi o raggi.	<b>IT</b>	To ensure the right tightening also with surfaces not perfectly flat, without spot-facing, concave convex and with different kinds of chamfers or radius.	<b>GB</b>	Eine vollständige Abdichtung ist auch auf unebenen Flächen, wie geneigt, konkav oder konvex und mit unterschiedlichen Radien oder Fasen gewährleistet.	<b>DE</b>
Pour permettre une parfaite étanchéité même sur des surfaces non planes, concaves, convexas ou inclinées et avec différents chanfreins ou rayons.	<b>FR</b>	Consentir una completa estanqueidad incluso en superficies no perfectamente planas, cóncavas, convexas o inclinadas, con diferentes ángulos o radios.	<b>ES</b>	Permite um aperto correto em superfícies não perfeitamente planas, côncavas, convexas ou inclinadas, com diferentes chanfros ou raios.	<b>PT</b>





### Coppia di serraggio

Torque specifications

Angaben Drehmoment

Couple de serrage

Par de apriete

Especificações de Torque



ISO 228



"UNIVERSAL SHORT"

MISURA MEASURE GRÖSSE DIMENSIONS MEDIDA MEDIDA	COPPIA CONSIGLIATA Nm RECOMMENDED TORQUE Nm EMPOFOHLENES DREHMOMENT Nm COUPLE DE SERRAGE Nm PAR ACONSEJADO Nm TORQUE RECOMENDADO Nm	COPPIA DI ROTTURA Nm BREAKING TORQUE Nm ABSCHERDREHMOMENT Nm COUPLE DE RUPTURE Nm PAR DE ROTURA Nm BINÁRIO ROMPER Nm
M5	0,8	3,2
1/8	3	8
1/4	9	30
3/8	10	60
1/2	12	50

MISURA MEASURE GRÖSSE DIMENSIONS MEDIDA MEDIDA	COPPIA MINIMA CONSIGLIATA Nm RECOMMENDED MINIMUM TORQUE Nm EMPOFOHLENES DREHMOMENT Nm COUPLE DE SERRAGE Nm PAR MÍNIMO ACONSEJADO Nm TORQUE MÍNIMO RECOMENDADO Nm	COPPIA MASSIMA CONSIGLIATA Nm RECOMMENDED MAX TORQUE Nm ABSCHERDREHMOMENT Nm COUPLE DE RUPTURE Nm PAR MÁXIMO ACONSEJADO Nm TORQUE MÁXIMA RECOMENDADO Nm
1/8	5	7
1/4	5	7
3/8	5	7
1/2	5	7

I valori di rottura possono variare in base all'articolo  
*Breaking values may vary according to the item*  
 Die maximal werte dienen nur zu informationszwecken  
 Les valeurs maximales sont présentées à titre indicatif  
 Los valores de rotura pueden variar en función del artículo  
 Los valores de força pode variar em função artigo

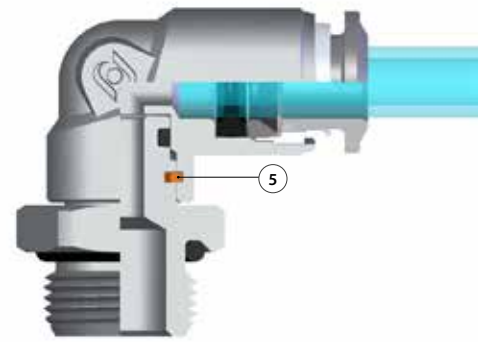
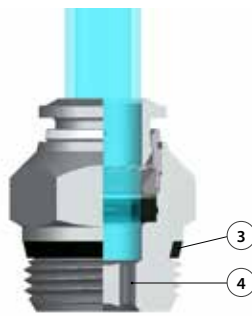
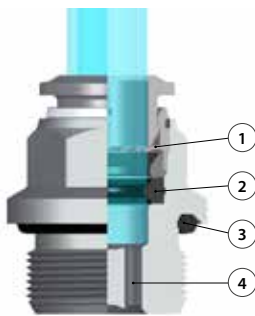

### Vantaggi

IT

- 1 La pinza in acciaio inox garantisce il perfetto aggraffaggio di tubi di qualsiasi materiale senza danneggiarne la superficie. Il collegamento tra tubo e raccordo assicura una tenuta totale anche in condizioni di urti e vibrazioni.
- 2 La particolare geometria della guarnizione permette inoltre l'utilizzo dei raccordi anche con il vuoto.
- 3 Tutte le filettature di questa serie sono state dotate di elementi di tenuta che permettono l'immediato utilizzo dei raccordi riducendo notevolmente i tempi di installazione.
- 4 Tutti i raccordi dritti possono essere montati anche con chiave esagonale ed è possibile utilizzarli anche in spazi molto ridotti.
- 5 Raccordo orientabile con anello di sicurezza interno. Garantisce maggiore durata alla rotazione e trazione.

### Advantages

GB

- 1 The washer is made in stainless steel ensures the perfect tube clamping with every kinds of materials without damage the surface. The connection between the tube and the fitting ensure a total tightness even in severe conditions such as impact and vibrations.
- 2 The particular geometric shape of the seal ensure the perfect tightness even with vacuum.
- 3 All of threads from this range have been equipped with tightening parts which allow the direct assembly of the fittings, reducing the installation time.
- 4 All the straight fittings can be assembled also with Allen wrench and it is possible to use them in reduced spaces.
- 5 Orienting fitting with safety ring inside. Improved durability to the rotation and traction.

### Vorteile

DE

- 1 Konisches Gewinde "kurz" Die Zahnscheibe sorgt für eine perfekte Halterung des Rohres ohne die Oberfläche zu beschädigen. Die Dichtheit zwischen Rohr und Verschraubung ist auch bei Erschütterungen und Vibrationen gewährleistet.
- 2 Die besondere Geometrie der Dichtung ermöglicht auch die Anwendung der Verschraubungen in Verbindung mit Vakuum.
- 3 Alle Verschraubungen in dieser Serie sind mit Gewindeabdichtungen ausgestattet, die den sofortigen Einsatz ermöglichen und daher die Montagezeit stark reduzieren.
- 4 Alle geraden Verschraubungen können auch mit Inbusschlüsseln montiert werden, daher kleiner Lochabstand möglich.
- 5 Flexible Montage mit Sicherungsring innen. Verbesserte Beständigkeit gegenüber der Drehung und Traktions.

### Avantages

FR

- 1 La rondelle en acier inoxydable garantit la parfaite tenue du tube quelle que soit la matière et sans l'endommager. La connexion entre le tube et le raccord assure une étanchéité totale même dans des conditions d'impact ou de vibrations.
- 2 La spécificité géométrique du joint permet l'utilisation des raccords avec le vide.
- 3 Tous les filetages de cette série sont équipés d'éléments d'étanchéité qui permettent l'utilisation immédiate des raccords réduisant ainsi le temps d'installation.
- 4 Tous les raccords droits peuvent être aussi montés avec une clé hexagonale pour permettre une utilisation dans des espaces réduits.
- 5 Accessoire de fixation réglable avec anneau de sécurité à l'intérieur. Amélioration de la durée de la rotation et de traction.

### Ventajas

ES

- 1 La pinza en acero inoxidable garantiza el perfecto agarre del tubo de cualquier material sin perjudicar la superficie. La conexión entre tubo y racor asegura una estanqueidad total aun en condiciones de impacto o vibración.
- 2 La particular geometría de la junta garantiza una perfecta estanqueidad incluso en vacío.
- 3 Todas las roscas de esta serie están fabricadas con junta de cierre que permite la inmediata utilización del racor reduciendo notablemente el tiempo de instalación.
- 4 Todos los racores rectos pueden montarse también con llave hexagonal y es posible utilizarlos incluso en espacios muy reducidos.
- 5 Montaje ajustable con sistema de seguridad interior. La mejora de la durabilidad a la rotación y tracción.

### Vantagens

PT

- 1 A pinça em aço-inox garante o perfeito travamento do tubo de qualquer material sem danificar a superfície do mesmo. A conexão entre o tubo e a conexão assegura uma vedação total também em condições de impactos e vibrações.
- 2 A geometria particular da vedação permite a utilização da conexão também para aplicações com vácuo.
- 3 Todas as roscas desta série são dotadas de elementos de vedação, o que permite a imediata utilização das conexões, reduzindo notavelmente o tempo de instalação.
- 4 Todas as conexões retas podem ser montadas também com chave allentornando possível montagem das mesmas em espaços bem reduzidos.
- 5 Montagem ajustável com anel de segurança dentro. A durabilidade melhorada para a rotação e tração.



Articoli in comune con serie 89000 per tubi pollici - Items in common with series 89000 for inch tubes  
 Gleicher Artikel wie in Serie 89000 für Zoll Rohre - Article identique avec la série 89000 pour tube en pouce  
 Artículos en común con la serie 89000 para tubos en pulgadas - Código em comum com a série 89000 para tubos em polegada

## 57000

### RACCORDO DIRITTO MASCHIO "UNIVERSAL SHORT"

STRAIGHT MALE ADAPTOR "UNIVERSAL SHORT"  
 GERADE EINSCHRAUBVERSCHRAUBUNG KONISCH "UNIVERSAL SHORT"  
 RACCORD DROIT MÂLE, CONIQUE "UNIVERSAL SHORT"  
 RACOR RECTO MACHO CÓNICO "UNIVERSAL SHORT"  
 CONEXÃO RETA COM ROSCA "UNIVERSAL SHORT"

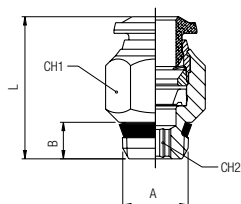

Code	Tube	A	B	L	CH1	CH2	Pack.
* 89000 00 003	4 (5/32)	1/8	5.5	18	11	3	10
* 89000 00 004	4 (5/32)	1/4	7	19	14	3	10
57000 00 011	5	1/8	5.5	20	11	4	10
57000 00 002	6	1/8	5.5	21.5	13	4	10
57000 00 003	6	1/4	7	21	14	4	10
57000 00 014	6	3/8	7.5	23	17	4	10
57000 00 015	6	1/2	9	23.5	21	4	10
* 89000 00 008	8 (5/16)	1/8	5.5	24.5	14	5	10
* 89000 00 009	8 (5/16)	1/4	7	22	14	6	10
* 89000 00 010	8 (5/16)	3/8	7.5	23	17	6	10
* 89000 00 022	8 (5/16)	1/2	9	23.5	21	6	10
57000 00 007	10	1/4	7	28	17	7	10
57000 00 008	10	3/8	7.5	25.5	17	8	10
57000 00 017	10	1/2	9	26	21	8	10
57000 00 009	12	1/4	7	31.5	20	7	10
57000 00 010	12	3/8	7.5	29.5	20	9	10
57000 00 018	12	1/2	9	31.5	21	10	10
57000 00 019	14	3/8	7.5	32.5	21	9	10
57000 00 020	14	1/2	9	31.5	21	10	10

## 57010

### RACCORDO DIRITTO MASCHIO ESAGONO INCASSATO

STRAIGHT MALE ADAPTOR WITH EXAGON EMBEDDED  
 GERADE EINSCHRAUBVERSCHRAUBUNG MIT INNENSECHSKANT  
 RACCORD DROIT MÂLE, CONIQUE, 6-PANS INTERIEUR  
 RACOR RECTO MACHO CÓNICO HEXÁGONO INTERIOR  
 CONEXÃO RETA COM SEXTAVADO INTERNO

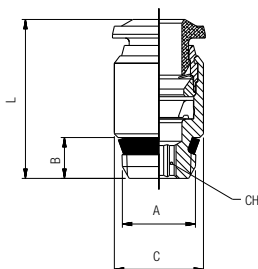

Code	Tube	A	B	C	L	CH	Pack.
* 89010 00 001	4 (5/32)	1/8	7.5	11	19	3	10
57010 00 003	6	1/8	7.5	12	22.5	4	10
57010 00 004	6	1/4	11	14	24.5	4	10
* 89010 00 002	8 (5/16)	1/8	7.5	14	25.5	5	10
* 89010 00 003	8 (5/16)	1/4	11	14	25	6	10

## 57010

### RACCORDO DIRITTO MASCHIO CILINDRICO ESAGONO INCASSATO

STRAIGHT MALE ADAPTOR (PARALLEL) WITH EXAGON EMBEDDED  
 GERADE EINSCHRAUBVERSCHRAUBUNG MIT INNENSECHSKANT ZYLINDRISCH  
 RACCORD DROIT MÂLE, CYLINDRIQUE, 6-PANS INTERIEUR  
 RACOR RECTO MACHO CILÍNDRICO CON TÓRICA HEXÁGONO INTERIOR  
 CONEXÃO RETA COM SEXTAVADO INTERNO E ROSCA MÉTRICA

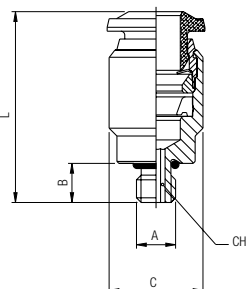

Code	Tube	A	B	C	L	CH	Pack.
57010 00 001	4	M5	4	10	21	2.5	10
57010 00 009	4	M7x1	5	10	21	2.5	10
57010 00 007	6	M5	4	12	24.5	2.5	10

## 57020

**New**
**RACCORDO DIRITTO MASCHIO CILINDRICO**

STRAIGHT MALE ADAPTOR (PARALLEL)

GERADE EINSCHRAUBVERSCHRAUBUNG ZYLINDRISCH

RACCORD DROIT MÂLE, CYLINDRIQUE

RACOR RECTO MACHO CILÍNDRICO CON TÓRICA

CONEXÃO RETA COM ROSCA PARALELA

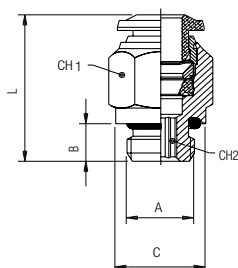

Code	Tube	A	B	C	L	CH1	CH2	Pack.
57020 00 001	4	M5	4	8	21	10	2	10
57020 00 002	4	1/8	6	13	20	10	3	10
57020 00 022	4	1/4	8	16	19.5	16	3	10
57020 00 018	5	M5	4	8	23.5	12	2	10
57020 00 019	5	1/8	6	13	22	12	4	10
57020 00 020	6	M5	4	10	24.5	13	2	10
57020 00 003	6	1/8	6	13	23.5	13	4	10
57020 00 004	6	1/4	8	16	23.5	13	4	10
57020 00 027	6	3/8	9	20	25	13	4	10
57020 00 028	6	1/2	10	25	27	13	4	10
57020 00 005	8	1/8	6	13	25	14	5	10
57020 00 006	8	1/4	8	16	23	14	6	10
57020 00 007	8	3/8	9	20	24	14	6	10
57020 00 029	8	1/2	10	25	26.5	14	6	10
57020 00 008	10	1/4	8	16	30.5	17	6	10
57020 00 009	10	3/8	9	20	27.5	17	8	10
57020 00 031	10	1/2	10	25	27	17	8	10
57020 00 032	12	1/4	8	16	34.5	20	6	10
57020 00 011	12	3/8	9	20	34	20	8	10
57020 00 023	12	1/2	10	25	31	22	10	10
57020 00 024	14	3/8	9	20	35	21	10	10
57020 00 025	14	1/2	10	25	32	22	11	10
57020 00 037	6	M8x1	5.4	12	24.5	13	3	10
57020 00 038	6	M10x1	5.4	13	23	13	4	10
57020 00 012	6	M12x1	8	15	23.5	13	4	10
57020 00 013	6	M12x1.25	8	15	23.5	13	4	10
57020 00 014	6	M12x1.5	8	15	23.5	13	4	10
57020 00 039	8	M8x1	5.4	12	25.5	14	4	10
57020 00 040	8	M10x1	5.4	13	25.5	14	4	10
57020 00 017	8	M12x1.5	8	15	27.5	14	6	10

## 57030

**RACCORDO DIRITTO FEMMINA**

STRAIGHT FEMALE ADAPTOR

AUFSCHRAUBVERSCHRAUBUNG

RACCORD DROIT, TARAUDE

RACOR RECTO HEMBRA

CONEXÃO RETA COM ROSCA FÊMEA

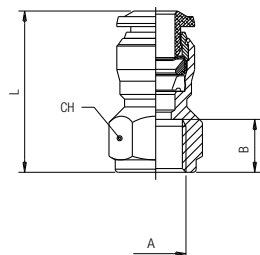

Code	Tube	A	B	L	CH	Pack.
57030 00 008	4	M5	5.5	21	11	10
57030 00 001	4	1/8	8.5	24	13	10
57030 00 009	4	1/4	11	27.5	16	10
57030 00 006	5	1/8	8.5	26.5	13	10
57030 00 002	6	1/8	8.5	26	13	10
57030 00 003	6	1/4	11	29.5	16	10
57030 00 004	8	1/8	8.5	27	15	10
57030 00 005	8	1/4	11	29.5	17	10
57030 00 010	8	3/8	12	32	19	10
57030 00 011	10	1/4	11	32	18	10
57030 00 012	10	3/8	12	33.5	19	10
57030 00 013	10	1/2	15	39	24	10
57030 00 014	12	3/8	12	36	21	10
57030 00 015	12	1/2	15	41	24	10

## 57040

**RACCORDO DIRITTO INTERMEDIO**

STRAIGHT CONNECTOR

VERBINDUNGSVERSCHRAUBUNG

RACCORD UNION DOUBLE

RACOR RECTO INTERMEDIO

CONEXÃO RETA TUBO-TUBO

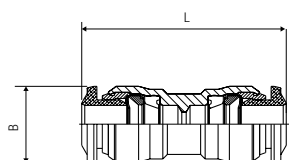

Code	Tube	Tube	L	B	Pack.
* 57040 00 001	4 (5/32)		30.5	10.5	10
57040 00 008	5		33	11.5	10
57040 00 002	6	4	32	12.5	10
57040 00 003	6		34	12.5	10
57040 00 004	8	6	35	14.5	10
* 57040 00 005	8 (5/16)		36	14.5	10
57040 00 011	10	8	40.5	17.5	10
57040 00 006	10		42	17.5	10
57040 00 012	12	10	45.5	20.5	10
57040 00 007	12		47	20.5	10
57040 00 010	14		49	21.5	10

**57050**

**RACCORDO DIRITTO INTERMEDIO DI ATTRAVERSAMENTO**

BULKHEAD CONNECTOR  
 SCHOTTVERSCHRAUBUNG  
 RACCORD TRAVERSÉE DE CLOISON  
 RACOR RECTO INTERMEDIO PASATABIQUES  
 CONEXÃO PASSA-MURO RETA TUBO-TUBO

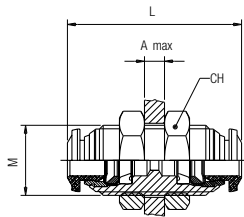

Code	Tube	M	L	CH	A max	Pack.
* 57050 00 001	4 (5/32)	M12x1	31.5	17	7	10
57050 00 006	5	M14x1	33	17	7	10
57050 00 002	6	M14x1	35	17	9.5	10
* 57050 00 003	8 (5/16)	M16x1	37	19	10.5	10
57050 00 004	10	M20x1	43	24	12.5	10
57050 00 005	12	M22x1	48	26	16.5	10

**57060**

**RACCORDO A L ORIENTABILE INTERMEDIO DI ATTRAVERSAMENTO**

BULKHEAD ORIENTING ELBOW  
 WINKEL-SCHOTTVERSCHRAUBUNG (DREHBAR)  
 RACCORD EQUERRE ORIENTABLE A TRAVERSEE DE CLOISON  
 RACOR A L ORIENTABLE INTERMEDIO PASATABIQUES  
 CONEXÃO PASSA-MURO EM "L" ORIENTÁVEL

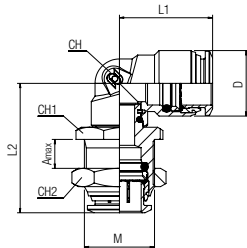

Code	Tube	M	L1	L2	CH	CH1	CH2	Amax	D	Pack.
* 57060 00 003	4 (5/32)	M12x1	17,5	26	9	14	17	6	10	10
57060 00 004	6	M14x1	21,5	31	11	16	17	6,5	12,5	10
* 57060 00 005	8 (5/16)	M16x1	22	34	12	18	19	6,5	14,5	10
57060 00 006	10	M20x1	26,5	36	14	22	24	7,5	17,5	10
57060 00 007	12	M22x1	30,5	43	16	24	26	9	21,5	10
57060 00 008	14	M23x1	30,5	43	16	25	27	9,5	21,5	10

**57100**

**RACCORDO A L MASCHIO CONICO**

ELBOW MALE ADAPTOR (TAPER)  
 WINKELVERSCHRAUBUNG KONISCH (NICHT DREHBAR)  
 EQUERRE NON ORIENTABLE MÂLE, CONIQUE (COURT)  
 RACOR A L MACHO CÔNICO  
 CONEXÃO MACHO EM "L" COM ROSCA CÔNICA

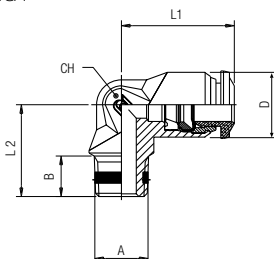

Code	Tube	A	B	L1	L2	CH	D	Pack.
57100 00 001	4	M5	5	17	15	9	10	10
57100 00 002	4	1/8	7.5	17	15.5	9	10	10
57100 00 010	5	M5	5	20	17	11	12.5	10
57100 00 011	5	1/8	7.5	20	17.5	11	12.5	10
57100 00 003	6	1/8	7.5	21	17.5	11	12.5	10
57100 00 012	6	1/4	11	21	21.5	11	12.5	10
57100 00 004	8	1/8	7.5	22.5	19	13	14	10
57100 00 005	8	1/4	11	22.5	21.5	13	14	10
57100 00 006	10	1/4	11	26.5	24.5	16	17	10
57100 00 007	10	3/8	11.5	26.5	24	16	17	10
57100 00 008	12	1/4	11	30.5	28	19	21.5	10
57100 00 009	12	3/8	11.5	30.5	28	19	21.5	10

**57106**

**RACCORDO A L ORIENTABILE FEMMINA**

ORIENTING ELBOW FEMALE ADAPTOR  
 AUFSCRAUB-WINKELSCHRAUBUNG (DREHBAR)  
 EQUERRE ORIENTABLE, FEMELLE  
 RACOR A L ORIENTABLE HEMBRA  
 CONEXÃO EM "L" ORIENTÁVEL COM ROSCA FÊMEA

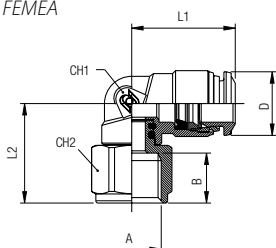

Code	Tube	A	B	L1	L2	CH1	CH2	D	Pack.
57106 00 001	4	1/8	8.5	18	20	9	13	10	10
57106 00 002	4	1/4	11	18	21.5	9	16	10	10
57106 00 003	6	1/8	8.5	21	20.5	11	13	12.5	10
57106 00 004	6	1/4	11	21	23	11	16	12.5	10
57106 00 005	8	1/8	8.5	22.5	20.5	12	13	14.5	10
57106 00 006	8	1/4	11	22.5	23	12	16	14.5	10



## 57111

### RACCORDO A L ORIENTABILE MASCHIO "UNIVERSAL SHORT"

ORIENTING ELBOW MALE ADAPTOR "UNIVERSAL SHORT"  
 WINKELVERSCHRAUBUNG KONISCH (DREHBAR) "UNIVERSAL SHORT"  
 EQUERRE ORIENTABLE MÂLE, CONIQUE "UNIVERSAL SHORT"  
 RACOR A L ORIENTABLE MACHO "UNIVERSAL SHORT"  
 CONEXÃO MACHO EM "L" ORIENTÁVEL COM ROSCA "UNIVERSAL SHORT"

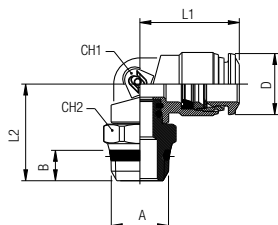

Code	Tube	A	B	L1	L2	CH1	CH2	D	Pack.
* 89111 00 003	4 (5/32)	1/8	5.5	18	19.5	9	13	10	10
* 89111 00 004	4 (5/32)	1/4	7	18	21	9	15	10	10
57111 00 004	6	1/8	5.5	21	21.5	11	13	12.5	10
57111 00 005	6	1/4	7	21	23	11	15	12.5	10
* 89111 00 008	8 (5/16)	1/8	5.5	22.5	22.5	12	13	14.5	10
* 89111 00 009	8 (5/16)	1/4	7	22.5	22.5	12	15	14.5	10
* 89111 00 010	8 (5/16)	3/8	7.5	22.5	23	12	17	14.5	10
* 89111 00 018	8 (5/16)	1/2	9	22.5	25.5	12	21	14.5	10
57111 00 010	10	1/4	7	26.5	26.5	14	16	17.5	10
57111 00 011	10	3/8	7.5	26.5	24.5	14	17	17.5	10
57111 00 012	10	1/2	9	26.5	27	14	21	17.5	10
57111 00 013	12	3/8	7.5	31.5	26.5	16	20	21.5	10
57111 00 014	12	1/2	9	31.5	29	16	21	21.5	10
57111 00 015	14	3/8	7.5	31.5	27	16	20	21.5	10
57111 00 016	14	1/2	9	31.5	29.5	16	21	21.5	10

## 57116

**New**

### RACCORDO A L ORIENTABILE MASCHIO CILINDRICO

ORIENTING ELBOW MALE ADAPTOR (PARALLEL)  
 WINKELVERSCHRAUBUNG ZYLINDRISCH (DREHBAR)  
 EQUERRE ORIENTABLE MÂLE, CYLINDRIQUE  
 RACOR A L ORIENTABLE MACHO CILÍNDRICO CON TÓRICA  
 CONEXÃO MACHO EM "L" ORIENTÁVEL COM ROSCA PARALELA

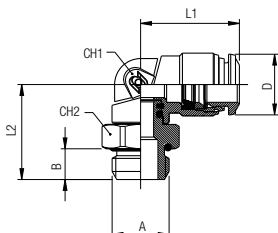

Code	Tube	A	B	L1	L2	CH1	CH2	D	Pack.
57116 00 002	4	M5	3.5	18	17.5	9	8	10	10
57116 00 003	4	1/8	5.5	18	18	9	13	10	10
57116 00 004	4	1/4	7	18	18	9	16	10	10
57116 00 005	5	M5	3.5	20	20	11	11	12.5	10
57116 00 006	5	1/8	5.5	20	20	11	13	12.5	10
57116 00 007	6	M5	3.5	21	20	11	11	12.5	10
57116 00 008	6	1/8	5.5	21	20	11	13	12.5	10
57116 00 009	6	1/4	7	21	21.5	11	16	12.5	10
57116 00 030	6	3/8	7.1	21	21.5	11	16	12.5	10
57116 00 010	8	1/8	5.5	22.5	21	12	13	14.5	10
57116 00 011	8	1/4	7	22.5	21.5	12	16	14.5	10
57116 00 012	8	3/8	8	22.5	23.5	12	20	14.5	10
57116 00 013	8	1/2	9.5	22.5	25	12	25	14.5	10
57116 00 014	10	1/4	7	26.5	25.5	14	16	17.5	10
57116 00 015	10	3/8	8	26.5	25	14	20	17.5	10
57116 00 016	10	1/2	9.5	26.5	26.5	14	25	17.5	10
57116 00 025	12	1/4	8	31.5	27.5	16	20	21.5	10
57116 00 017	12	3/8	8	31.5	27	16	20	21.5	10
57116 00 018	12	1/2	9.5	31.5	28.5	16	25	21.5	10
57116 00 019	14	3/8	8	31.5	27.5	16	20	21.5	10
57116 00 020	14	1/2	9.5	31.5	29	16	25	21.5	10
57116 00 021	6	M12x1	7.5	20	22	11	16	12.5	10
57116 00 022	6	M12x1.25	7.5	20	22	11	16	12.5	10
57116 00 023	6	M12x1.5	7.5	20	22	11	16	12.5	10
57116 00 024	8	M12x1.5	7.5	22.5	22	12	16	14.5	10

## 57126

### RACCORDO A L ORIENTABILE PROLUNGATO MASCHIO CILINDRICO

EXTENDED ORIENTING ELBOW MALE ADAPTOR (PARALLEL)  
 VERLÄNGERTE WINKELVERSCHRAUBUNG ZYLINDRISCH (DREHBAR)  
 EQUERRE PROLONGÉE ORIENTABLE MÂLE, CYLINDRIQUE  
 RACOR A L ORIENTABLE PROLONGADO MACHO CILÍNDRICO CON TÓRICA  
 CONEXÃO MACHO EM "L" PROLONGADO COM ROSCA PARALELA

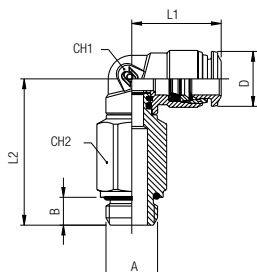

Code	Tube	A	B	L1	L2	CH1	CH2	D	Pack.
57126 00 001	4	1/8	5.5	18	30	9	12	10	10
57126 00 002	4	1/4	7	18	32	9	15	10	10
57126 00 003	5	1/8	5.5	20	34.5	11	12	12.5	10
57126 00 004	6	1/8	5.5	21	34.5	11	12	12.5	10
57126 00 005	6	1/4	7	21	36	11	15	12.5	10
57126 00 006	8	1/8	5	22.8	37.5	12	12	14.5	10
57126 00 007	8	1/4	7	22.5	38	12	15	14.5	10
57126 00 008	8	3/8	8	22.5	40	12	18	14.5	10
57126 00 009	10	1/4	7	26.5	45	14	16	17.5	10
57126 00 010	10	3/8	8	26.5	44.5	14	18	17.5	10

## 57130

### RACCORDO A L INTERMEDIO

ELBOW CONNECTOR  
WINKEL-ANSCHLUSS  
RACCORD EQUERRE EGALE  
RACOR A L INTERMEDIO  
CONEXÃO EM "L" TUBO-TUBO

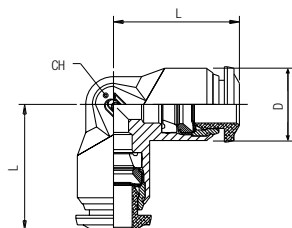

Code	Tube	L	CH	D	Pack.
* 57130 00 001	4 (5/32)	17	9	10	10
57130 00 006	5	20	11	12.5	10
57130 00 002	6	21	11	12.5	10
* 57130 00 003	8 (5/16)	22.5	13	14	10
57130 00 004	10	26.5	16	17	10
57130 00 005	12	30.5	19	21.5	10
57130 00 008	14	32.5	19	21.5	10

## 57200

### RACCORDO A T MASCHIO CONICO

TEE MALE ADAPTOR (TAPER) CENTRE LEG  
T-EINSCHRAUBVERSCHRAUBUNG KONISCH (NICHT DREHBAR)  
TÉ NON ORIENTABLE À PIQUAGE MÂLE CENTRAL, CONIQUE (COURT)  
RACOR A T MACHO CENTRAL CÔNICO  
CONEXÃO MACHO EM "T" ORIENTÁVEL COM ROSCA CÔNICA

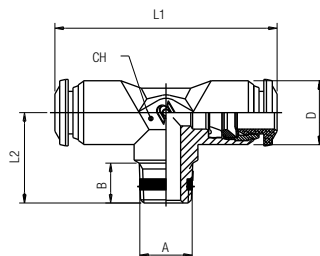

Code	Tube	A	B	L1	L2	CH	D	Pack.
57200 00 001	4	M5	5	34	15	9	10	10
57200 00 002	4	1/8	7.5	34	15.5	9	10	10
57200 00 010	5	1/8	7.5	40	17.5	11	12.5	10
57200 00 003	6	1/8	7.5	42	17.5	11	12.5	10
57200 00 004	8	1/8	7.5	45	19	13	14	10
57200 00 005	8	1/4	11	45	21.5	13	14	10
57200 00 006	10	1/4	11	53	24.5	16	17	10
57200 00 007	10	3/8	11.5	53	24	16	17	10
57200 00 008	12	1/4	11	61	28	19	21.5	10
57200 00 009	12	3/8	11.5	61	28	19	21.5	10

## 57211

### RACCORDO A T ORIENTABILE MASCHIO "UNIVERSAL SHORT"

ORIENTING TEE MALE ADAPTOR "UNIVERSAL SHORT" - CENTRE LEG  
T-EINSCHRAUBVERSCHRAUBUNG KONISCH (DREHBAR) "UNIVERSAL SHORT"  
TÉ ORIENTABLE À PIQUAGE MÂLE CENTRAL, CONIQUE "UNIVERSAL SHORT"  
RACOR A T ORIENTABLE MACHO CENTRAL CÔNICO "UNIVERSAL SHORT"  
CONEXÃO EM "T" CENTRAL ORIENTÁVEL COM ROSCA MACHO "UNIVERSAL SHORT"

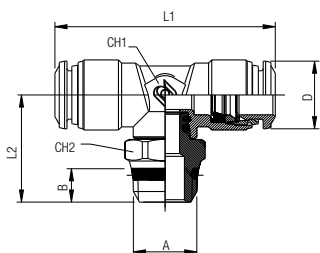

Code	Tube	A	B	L1	L2	CH1	CH2	D	Pack.
* 89211 00 003	4 (5/32)	1/8	5.5	34	20	9	13	10	10
* 89211 00 004	4 (5/32)	1/4	7	34	21.5	9	15	10	10
57211 00 004	6	1/8	5.5	42	22	11	13	12.5	10
57211 00 005	6	1/4	7	42	23.5	11	15	12.5	10
* 89211 00 016	8 (5/16)	1/8	5.5	45	25.5	13	13	14.5	10
* 89211 00 015	8 (5/16)	1/4	7	45	25.5	13	15	14.5	10
* 89211 00 017	8 (5/16)	3/8	7.5	45	26	13	17	14.5	10
57211 00 010	10	1/4	7	53	29	14	16	17.5	10
57211 00 011	10	3/8	7.5	53	27	14	17	17.5	10
57211 00 012	10	1/2	9	53	29.5	14	21	17.5	10
57211 00 013	12	3/8	7.5	62.5	29.5	16	20	21.5	10
57211 00 014	12	1/2	9	62.5	32	16	21	21.5	10

## 57216

### RACCORDO A T ORIENTABILE MASCHIO CILINDRICO

ORIENTING TEE MALE ADAPTOR (PARALLEL) - CENTRE LEG  
 T-EINSCHRAUBVERSCHRAUBUNG ZYLINDRISCH (DREHBAR)  
 TÉ ORIENTABLE À PIQUAGE MÂLE CENTRAL, CYLINDRIQUE  
 RACOR A T ORIENTABLE MACHO CENTRAL CILÍNDRICO CON TÓRICA  
 CONEXÃO MACHO EM "T" ORIENTÁVEL COM ROSCA PARALELA

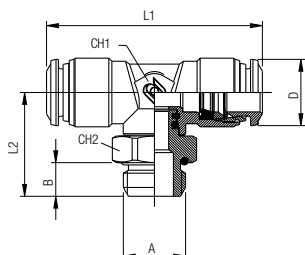

Code	Tube	A	B	L1	L2	CH1	CH2	D	Pack.
57216 00 002	4	M5	3.5	34	18	9	8	10	10
57216 00 003	4	1/8	5.5	34	18.5	9	13	10	10
57216 00 004	4	1/4	7	34	20	9	16	10	10
57216 00 005	5	M5	3.5	40	20.5	11	11	12.5	10
57216 00 006	5	1/8	5.5	40	20.5	11	13	12.5	10
57216 00 007	6	M5	3.5	42	20.5	11	11	12.5	10
57216 00 008	6	1/8	5.5	42	20.5	11	13	12.5	10
57216 00 009	6	1/4	7	42	22	11	16	12.5	10
57216 00 010	8	1/8	5.5	45	23.5	13	13	14.5	10
57216 00 011	8	1/4	7	45	24	13	16	14.5	10
57216 00 012	8	3/8	8	45	26	13	20	14.5	10
57216 00 013	8	1/2	9.5	45	27.5	13	25	14.5	10
57216 00 014	10	1/4	7	53	27.5	14	16	17.5	10
57216 00 015	10	3/8	8	53	27	14	20	17.5	10
57216 00 016	10	1/2	9.5	53	28.5	14	25	17.5	10
57216 00 017	12	3/8	8	62.5	29.5	16	20	21.5	10
57216 00 018	12	1/2	9.5	62.5	31	16	25	21.5	10
57216 00 019	14	3/8	8	62.5	29.5	16	20	21.5	10
57216 00 020	14	1/2	9.5	62.5	31	16	25	21.5	10
57216 00 021	6	M12x1	7.5	42	22	11	16	12.5	10
57216 00 022	6	M12x1.25	7.5	42	22	11	16	12.5	10
57216 00 023	6	M12x1.5	7.5	42	22	11	16	12.5	10

## 57223

### RACCORDO A T ORIENTABILE MASCHIO LATERALE "UNIVERSAL SHORT"

ORIENTING TEE MALE ADAPTOR "UNIVERSAL SHORT" OFF - SET LEG  
 L-EINSCHRAUBVERSCHRAUBUNG KONISCH (DREHBAR) "UNIVERSAL SHORT"  
 TÉ ORIENTABLE À PIQUAGE LATÉRAL, CONIQUE "UNIVERSAL SHORT"  
 RACOR A T ORIENTABLE MACHO LATERAL CÓNICO "UNIVERSAL SHORT"  
 CONEXÃO EM "T" LATERAL ORIENTÁVEL COM ROSCA MACHO "UNIVERSAL SHORT"

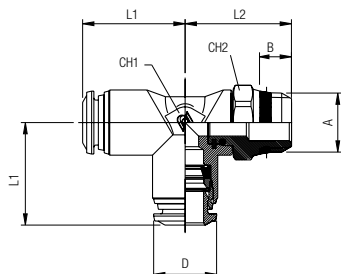

Code	Tube	A	B	L1	L2	CH1	CH2	D	Pack.
* 89223 00 003	4 (5/32)	1/8	5.5	17	20	9	13	10	10
* 89223 00 004	4 (5/32)	1/4	7	17	21.5	9	15	10	10
57223 00 004	6	1/8	5.5	21	22	11	13	12.5	10
57223 00 005	6	1/4	7	21	23.5	11	15	12.5	10
* 89223 00 015	8 (5/16)	1/8	5.5	22.5	24	13	13	14.5	10
* 89223 00 016	8 (5/16)	1/4	7	22.5	24	13	15	14.5	10
* 89223 00 017	8 (5/16)	3/8	7.5	22.5	27	13	17	14.5	10
57223 00 010	10	1/4	7	26.5	26	14	16	17.5	10
57223 00 011	10	3/8	7.5	26.5	26	14	17	17.5	10
57223 00 012	10	1/2	9	26.5	28.5	14	21	17.5	10
57223 00 013	12	3/8	7.5	31.5	29.5	16	20	21.5	10
57223 00 014	12	1/2	9	31.5	32	16	21	21.5	10

## 57226

### RACCORDO A T ORIENTABILE MASCHIO LATERALE CILINDRICO

ORIENTING TEE MALE ADAPTOR (PARALLEL) - OFF - SET LEG  
 L-EINSCHRAUBVERSCHRAUBUNG ZYLINDRISCH (DREHBAR)  
 TÉ ORIENTABLE À PIQUAGE LATÉRAL, CYLINDRIQUE  
 RACOR A T ORIENTABLE MACHO LATERAL CILÍNDRICO CON TÓRICA  
 CONEXÃO MACHO EM "T" LATERAL ORIENTÁVEL COM ROSCA PARALELA

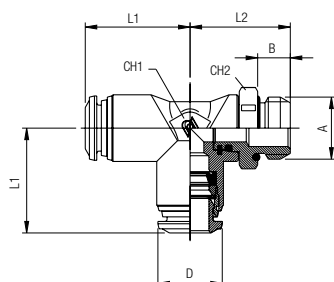

Code	Tube	A	B	L1	L2	CH1	CH2	D	Pack.
57226 00 002	4	M5	3.5	17	18	9	8	10	10
57226 00 003	4	1/8	5.5	17	18.5	9	13	10	10
57226 00 004	4	1/4	7	17	20	9	16	10	10
57226 00 005	5	M5	3.5	20	20.5	11	11	12.5	10
57226 00 006	5	1/8	5.5	20	20.5	11	13	12.5	10
57226 00 007	6	M5	3.5	21	20.5	11	11	12.5	10
57226 00 008	6	1/8	5.5	21	20.5	11	13	12.5	10
57226 00 009	6	1/4	7	21	22	11	16	12.5	10
57226 00 010	8	1/8	5.5	22.5	22.5	13	13	14.5	10
57226 00 011	8	1/4	7	22.5	23	13	16	14.5	10
57226 00 012	8	3/8	8	22.5	25	13	20	14.5	10
57226 00 013	8	1/2	9.5	22.5	26.5	13	25	14.5	10
57226 00 014	10	1/4	7	26.5	27	14	16	17.5	10
57226 00 015	10	3/8	8	26.5	26.5	14	20	17.5	10
57226 00 016	10	1/2	9.5	26.5	28	14	25	17.5	10
57226 00 017	12	3/8	8	31.5	29.5	16	20	21.5	10
57226 00 018	12	1/2	9.5	31.5	31	16	25	21.5	10
57226 00 021	6	M12x1	7.5	21	22	11	16	12.5	10
57226 00 022	6	M12x1.25	7.5	21	22	11	16	12.5	10
57226 00 023	6	M12x1.5	7.5	21	22	11	16	12.5	10

### 57230

**RACCORDO A T INTERMEDIO**  
 TEE CONNECTOR  
 T-ANSCHLUSS  
 RACCORD TÉ  
 RACOR A T INTERMEDIO  
 CONEXÃO EM "T" TUBO-TUBO

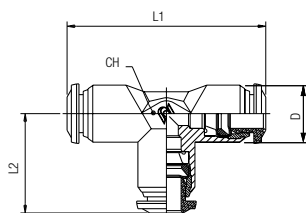

Code	Tube	L1	L2	CH	D	Pack.
* 57230 00 001	4 (5/32)	34	17	9	10	10
57230 00 006	5	40	20	11	12.5	10
57230 00 002	6	42	21	11	12.5	10
* 57230 00 003	8 (5/16)	45	22.5	13	14	10
57230 00 004	10	53	26.5	16	17	10
57230 00 005	12	61	30.5	19	21.5	10
57230 00 008	14	65.5	32.5	19	21.5	10

### 57310

**RACCORDO A Y INTERMEDIO**  
 Y CONNECTOR  
 Y-ANSCHLUSS  
 RACCORD Y SIMPLE  
 RACOR A Y INTERMEDIO  
 CONEXÃO EM "Y" TUBO-TUBO

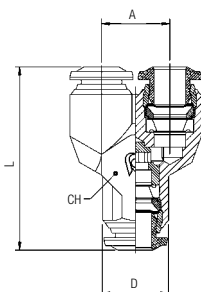

Code	Tube	A	L	CH	D	Pack.
* 57310 00 001	4 (5/32)	11	32	11	10	10
57310 00 004	5	13.5	35	13	12.5	10
57310 00 002	6	13.5	36.5	13	12.5	10
* 57310 00 003	8 (5/16)	15.5	41	15	14	10
57310 00 008	10	18.5	48	18	17	10

### 57500

**ANELLO A L ORIENTABILE**  
 SINGLE BANJO BODY  
 RINGANSCHLUSS  
 CORPS SIMPLE POUR BANJO  
 ANILLO ORIENTABLE SIMPLE  
 ANEL ORIENTÁVEL EM "L"

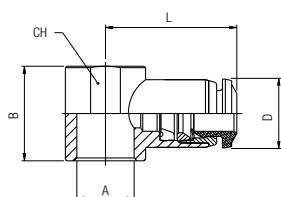

Code	Tube	A	B	L	CH	D	Pack.
* 57500 00 001	4 (5/32)	M5(10/32)	12.5	19	-	10	10
57500 00 002	4	M6	12.5	19	-	10	10
* 57500 00 003	4 (5/32)	1/8	15	21	14	10	10
57500 00 013	5	M5	12.5	20	-	12.5	10
57500 00 017	5	M6	12.5	20	-	12.5	10
57500 00 014	5	1/8	15	21.5	14	12.5	10
57500 00 015	5	1/4	17	24.5	18	12.5	10
57500 00 016	6	M5	12.5	20.5	-	12.5	10
57500 00 018	6	M6	12.5	20.5	-	12.5	10
57500 00 004	6	1/8	15	22	14	12.5	10
57500 00 005	6	1/4	17	25	18	12.5	10
* 57500 00 006	8 (5/16)	1/8	15	24	14	14	10
* 57500 00 007	8 (5/16)	1/4	17	26	18	14	10
* 57500 00 008	8 (5/16)	3/8	20	28	21	14	10
57500 00 009	10	1/4	17	29	18	17	10
57500 00 010	10	3/8	20	30.5	21	17	10
57500 00 012	12	3/8	20	32.5	21	21.5	10
57500 00 021	12	1/2	24	35	25	21.5	10
57500 00 022	14	1/2	24	35.5	25	21.5	10

### 57510

**ANELLO A T ORIENTABILE**  
 DOUBLE BANJO BODY  
 DOPPELTER RINGANSCHLUSS  
 CORPS DOUBLE POUR BANJO  
 ANILLO ORIENTABLE DOBLE  
 ANEL ORIENTÁVEL EM "T"

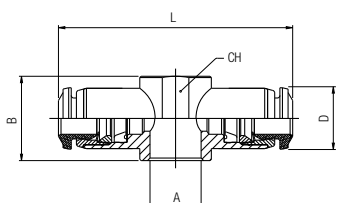

Code	Tube	A	B	L	CH	D	Pack.
* 57510 00 001	4 (5/32)	M5	12.5	38	-	10	10
* 57510 00 002	4 (5/32)	M6	12.5	38	-	10	10
* 57510 00 003	4 (5/32)	1/8	15	42	14	10	10
57510 00 008	5	1/8	15	43	14	12.5	10
57510 00 009	5	1/4	17	49	18	12.5	10
57510 00 004	6	1/8	15	44	14	12.5	10
57510 00 005	6	1/4	17	50	18	12.5	10
* 57510 00 006	8 (5/16)	1/8	15	48	14	14	10
* 57510 00 007	8 (5/16)	1/4	17	52	18	14	10

## 57550

### RACCORDO A L ORIENTABILE MASCHIO CILINDRICO

ORIENTING SINGLE BANJO BODY MALE  
 WINKELSCHWENKVERSCHRAUBUNG ZYLINDRISCH (DREHBAR)  
 EQUERRE MÂLE BANJO, ORIENTABLE  
 RACOR ORIENTABLE SIMPLE CON TÓRICA  
 CONEXÃO BANJO EM "L" COM ROSCA PARALELA

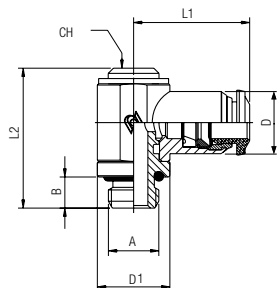

Code	Tube	A	B	L1	L2	CH	D1	D	Pack.
57550 00 001	4	M5	3.6	19	24.5	-	CH8	10	10
57550 00 002	4	1/8	6	21	28	5	14	10	10
57550 00 012	5	M5	3.6	20	24.5	-	CH8	12.5	10
57550 00 013	5	1/8	6	21.5	28	5	14	12.5	10
57550 00 014	5	1/4	8	24.5	31	6	18	12.5	10
57550 00 015	6	M5	3.6	20.5	24.5	-	CH8	12.5	10
57550 00 003	6	1/8	6	22.5	28	5	14	12.5	10
57550 00 004	6	1/4	8	25	31	6	18	12.5	10
57550 00 005	8	1/8	6	24	28	5	14	14	10
57550 00 006	8	1/4	8	26	31	6	18	14	10
57550 00 007	8	3/8	9	28	35.5	7	21	14	10
57550 00 008	10	1/4	8	29	31	6	18	17	10
57550 00 009	10	3/8	9	30.5	35.5	7	21	17	10
57550 00 011	12	3/8	9	32.5	35.5	7	21	21.5	10

## 57560

### RACCORDO A T ORIENTABILE MASCHIO CILINDRICO

ORIENTING DOUBLE BANJO BODY MALE  
 T-SCHWENKVERSCHRAUBUNG ZYLINDRISCH (DREHBAR)  
 TÉ MÂLE BANJO, ORIENTABLE  
 RACOR ORIENTABLE DOBLE CON TÓRICA  
 CONEXÃO BANJO EM "T" ORIENTÁVEL COM ROSCA PARALELA

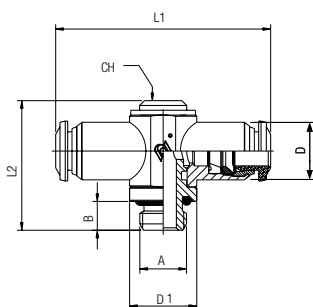

Code	Tube	A	B	L1	L2	D1	CH	D	Pack.
57560 00 002	4	1/8	6	42	27	14	5	10	10
57560 00 008	5	1/8	6	43	27	14	5	12.5	10
57560 00 009	5	1/4	8	49	31	18	6	12.5	10
57560 00 003	6	1/8	6	45	27	14	5	12.5	10
57560 00 004	6	1/4	8	50	31	18	6	12.5	10
57560 00 005	8	1/8	6	48	27	14	5	14	10
57560 00 006	8	1/4	8	52	31	18	6	14	10

## 51410

### VITE CAVA SINGOLA

BANJO STEM SINGLE  
 EINFACHE HOHLSCHRAUBE  
 VIS POUR BANJO SIMPLE  
 TORNILLO SIMPLE  
 HASTE PARA CONEXÃO BANJO COM 1 CAVIDADE

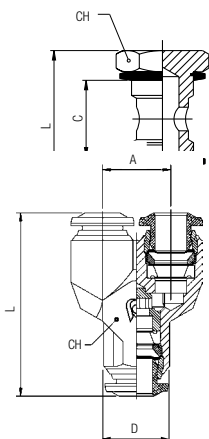

Code	A	B	C	L	CH	Pack.
51410 00 011	M5	4	12.5	22	8	10
51410 00 012	M6	5	12.5	23	8	10
51410 00 013	1/8	6	15	28	14	10
51410 00 014	1/4	8	17	32	17	10
51410 00 015	3/8	9	20	36	19	10
51410 00 016	1/2	10	24	42	24	10
51410 00 017	*M12x1.5	8	17	32	17	10

Questo articolo viene fornito completo di rondelle in PA66 (ART. 1610).

This item will be supplied with the PA66 washers (ART. 1610).

Dieser artikel wird mit dichtungen aus PA66 (ART. 1610) Mitgeliefert.

Livré avec joints en PA66 (ART. 1610).

Este artículo viene completo de arandelas en nylon (ART. 1610).

Este item vem acompanhado de arruelas em PA66 (CÓD. 1610).

\* Con questa vite utilizzare gli anelli orientabili da 1/4.

\* With this banjo stem using 1/4 orienting banjo body.

\* Bei dieser größe können dichtringe für 1/4 eingesetzt werden.

\* Compatible avec joint 1/4.

\* Con este tornillo utilizar el anillo orientable de 1/4.

\* Com esta haste para banjo utilizar os anéis orientáveis de 1/4.



### 51420

**VITE CAVA DOPPIA**

BANJO STEM DOUBLE  
 DOPPELTE HOHLSCHRAUBE  
 VIS POUR BANJO DOUBLE  
 TORNILLO DOBLE  
 HASTE PARA CONEXÃO BANJO COM 2 CAVIDADES

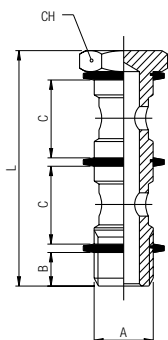

Code	A	B	C	L	CH	Pack.
51420 00 011	1/8	6	15	44.5	14	10
51420 00 012	1/4	8	17	50.5	17	10
51420 00 013	3/8	9	20	58	19	10
51420 00 014	1/2	10	24	68	24	10
51420 00 015	*M12x1.5	8	17	50.5	17	10

Questo articolo viene fornito completo di rondelle in PA66 (ART. 1610).  
 This item will be supplied with the PA66 washers (ART. 1610).  
 Dieser artikel wird mit dichtringen aus PA66 (ART. 1610) Mitgeliefert.  
 Livré avec joints en PA66 (ART. 1610).  
 Este artículo viene completo de arandelas en nylon (ART. 1610).  
 Este item vem acompanhado de arruelas em PA66 (CÓD. 1610).

- \* Con questa vite utilizzare gli anelli orientabili da 1/4.
- \* With this banjo stem using 1/4 orienting banjo body.
- \* Bei dieser größe können dichtringe für 1/4 eingesetzt werden.
- \* Compatible avec joint 1/4.
- \* Con este tornillo utilizar el anillo orientable de 1/4.
- \* Com esta haste para banjo utilizar os anéis orientáveis de 1/4.

### 51430

**VITE CAVA TRIPLA**

BANJO STEM TRIPLE  
 DREIFACH HOHLSCHRAUBE  
 VIS POUR BANJO TRIPLE  
 TORNILLO TRIPLE  
 HASTE PARA CONEXÃO BANJO COM 3 CAVIDADES

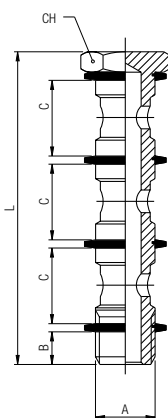

Code	A	B	C	L	CH	Pack.
51430 00 011	1/8	6	15	61	14	10
51430 00 012	1/4	8	17	69	17	10
51430 00 013	3/8	9	20	80	19	10
51430 00 014	1/2	10	24	94	24	10

Questo articolo viene fornito completo di rondelle in PA66 (ART. 1610).  
 This item will be supplied with the PA66 washers (ART. 1610).  
 Dieser artikel wird mit dichtringen aus PA66 (ART. 1610) Mitgeliefert.  
 Livré avec joints en PA66 (ART. 1610).  
 Este artículo viene completo de arandelas en nylon (ART. 1610).  
 Este item vem acompanhado de arruelas em PA66 (CÓD. 1610).

### 51440

**VITE CAVA SINGOLA MASCHIO - FEMMINA**

MALE - FEMALE BANJO STEM SINGLE  
 AUFSCRAUBHOHLSCHRAUBE MIT INNENGEWINDE  
 VIS CREUSE TARAUDÉE POUR BANJO SIMPLE  
 TORNILLO SIMPLE MACHO - HEMBRA  
 HASTE PARA CONEXÃO BANJO COM 1 CAVIDADE MACHO - FÊMEA

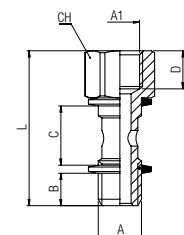

Code	A	A1	B	C	D	L	CH	Pack.
51440 00 001	1/8	1/8	6	15	8.5	34.5	14	10
51440 00 002	1/4	1/4	8	17	11	40.5	17	10
51440 00 003	3/8	3/8	9	20	12	45.5	19	10

Questo articolo viene fornito completo di rondelle in PA66 (ART. 1610).  
 This item will be supplied with the PA66 washers (ART. 1610).  
 Dieser artikel wird mit dichtringen aus PA66 (ART. 1610) Mitgeliefert.  
 Livré avec joints en PA66 (ART. 1610).  
 Este artículo viene completo de arandelas en nylon (ART. 1610).  
 Este item vem acompanhado de arruelas em PA66 (CÓD. 1610).

### 50600

**ADATTATORE MASCHIO CILINDRICO**

MALE ADAPTOR PARALLEL  
 EINSCHRAUBSTECKVERSCHRAUBUNG ZYLINDRISCH  
 ADAPTEUR ENCLIQUETABLE MÂLE, CYLINDRIQUE  
 ADAPTADOR MACHO CILÍNDRICO CON TÓRICA  
 ADAPTADOR MACHO COM ROSCA PARALELA

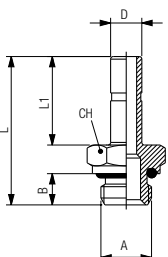

Code	D	A	B	L	L1	CH	Pack.
50600 00 001	4	M5	4	24	15	8	10
50600 00 002	4	1/8	6	26.5	15	13	10
50600 00 012	5	M5	4	26	17	8	10
50600 00 013	5	1/8	6	28.5	17	13	10
50600 00 014	5	1/4	8	31	17	16	10
50600 00 015	6	M5	4	26	17	8	10
50600 00 003	6	1/8	6	28.5	17	13	10
50600 00 004	6	1/4	8	31	17	16	10
50600 00 005	8	1/8	6	29.5	18	13	10
50600 00 006	8	1/4	8	32	18	16	10
50600 00 007	8	3/8	9	33.5	18	20	10
50600 00 016	10	1/8	6	33.5	22	13	10
50600 00 008	10	1/4	8	36	22	16	10
50600 00 009	10	3/8	9	37.5	22	20	10
50600 00 010	12	1/4	8	38.5	24.5	16	10
50600 00 011	12	3/8	9	40	24.5	20	10
50600 00 018	14	1/2	10	44	26.5	24	10

## 57610

**TAPPO**  
 PLUG  
 VERSCHLUSSZAPFEN  
 BOUCHON ENCLIQUETABLE  
 TAPÓN  
 TAMPÃO

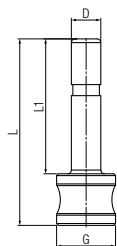

Code	D	G	L	L1	Pack.
* 57610 00 01 X1 NB	4 (5/32)	8	25,5	18,5	10
57610 00 01 X3 NB	5	8	27	20	10
57610 00 01 X4 NB	6	8	27,5	20,5	10
* 57610 00 01 X7 NB	8 (5/16)	12	29,5	21,5	10
57610 00 01 X9 NB	10	12	32,5	24,5	10
57610 00 01 Y1 NB	12	16	36,5	27,5	10
57610 00 01 Y3 NB	14	16	35,5	26,5	10

## 50625

**GIUNZIONE DOPPIA**  
 DOUBLE JOINT  
 DOPPELSTECKER  
 JONCTION DOUBLE  
 UNIÓN DOBLE  
 JUNÇÃO DUPLA

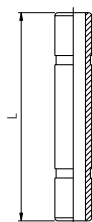

Code	Tube	L	Pack.
* 50625 00 01 X1 NB	4 (5/32)	31	10
50625 00 01 X3 NB	5	33	10
50625 00 01 X4 NB	6	34	10
* 50625 00 01 X7 NB	8 (5/16)	36	10
50625 00 01 X9 NB	10	45	10
50625 00 01 Y1 NB	12	50	10

## 57700

**RIDUZIONE**  
 REDUCER  
 REDUZIERUNG  
 RÉDUCTION ENCLIQUETABLE  
 REDUCCIÓN  
 REDUÇÃO

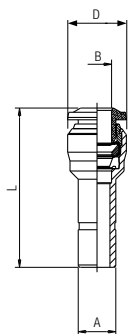

Code	A	B	L	D	Pack.
57700 00 004	5	4	29	10.5	10
57700 00 001	6	4	30	10.5	10
57700 00 005	6	5	32	11.5	10
* 57700 00 008	8 (5/16)	4 (5/32)	33	10.5	10
57700 00 002	8	6	34	14	10
57700 00 009	10	4	32	10	10
57700 00 003	10	8	38	14.5	10
57700 00 007	12	8	39	14.5	10
57700 00 010	12	10	43	17.5	10

## 57800

**CARTUCCE A COMPRESIONE**  
 PUSH-FIT CARTRIDGES  
 EINPRESSPATRONEN  
 CARTOUCHE  
 CARTUCHO A COMPRESIÓN  
 CARTUCHO DE COMPRESSÃO

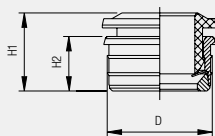

Code	Tube	D	H1	H2	Pack.
57800 00 001	4	8.7	10.4	5.6	25
57800 00 002	5	9.75	11.8	6.3	25
57800 00 003	6	10.75	12.4	6.9	25
57800 00 004	8	12.7	12.4	6.9	25
57800 00 005	10	15.7	15.7	8.5	25
57800 00 006	12	18.3	17.8	9.5	25

Dimensioni sedi cartucce a compressione.  
 Seats dimensions push-fit cartridges.  
 Bohrungsangaben für die einpresspatronen.  
 Dimensions des logements des cartouches.  
 Dimensiones sede cartucho a compresión.  
 Dimensão da sede do cartucho de compressão.

**SEDE**  
 SEAT  
 BOHRUNGEN  
 IMPLANTATION  
 SEDE  
 SEDE

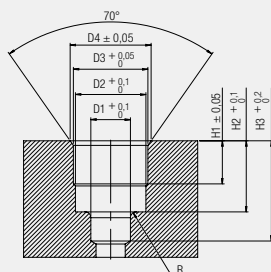

Tube	D1	D2	D3	D4	H1	H2	H3	R
4	4.2	7.45	8.4	9	3.75	6.5	9.5	0.5
5	5.2	8.35	9.4	10.15	4.45	7.9	10.5	0.5
6	6.2	9.35	10.45	11.35	5	8.5	11.5	0.5
8	8.2	11.4	12.4	12.9	5.2	8.5	12.5	0.75
10	10.2	14.5	15.4	16	6.7	10.5	15	0.75
12	12.2	17	18	19	7.5	12.1	17	1